

A

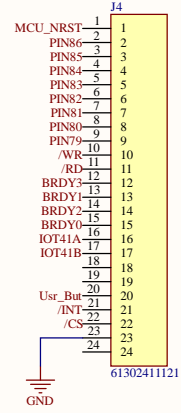
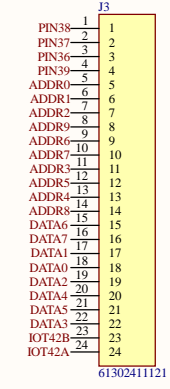
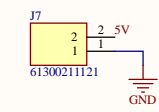
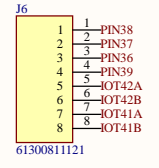
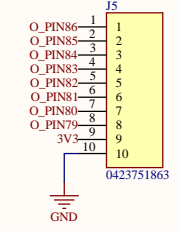
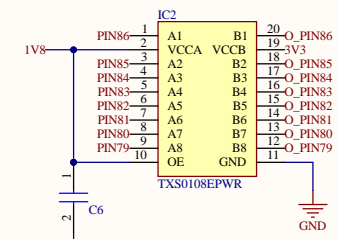
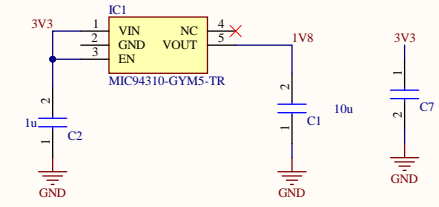
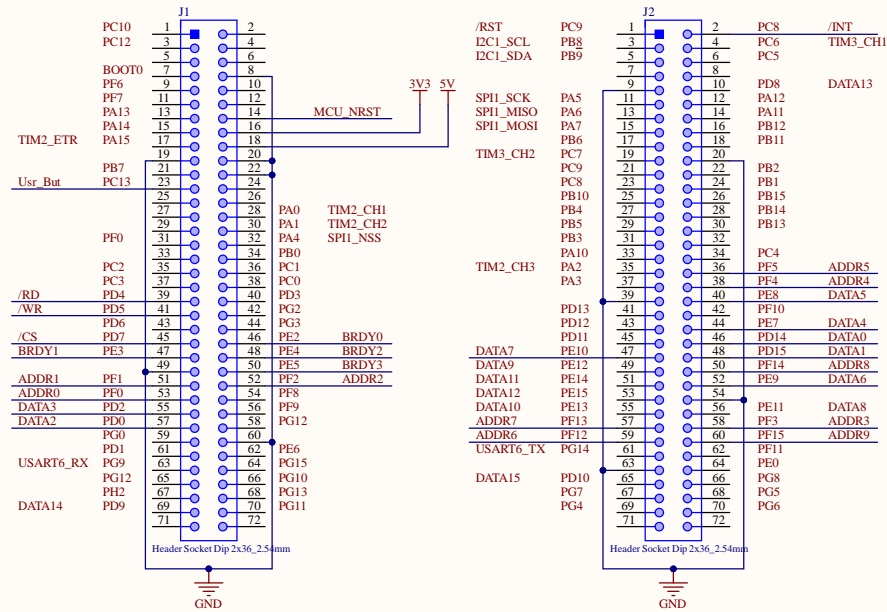

B

C

D

Title		
Size	Number	Revision
A3		
Date:	8/19/2023	Sheet of
File:	C:\Users\...interface_board.SchDoc	Drawn By:

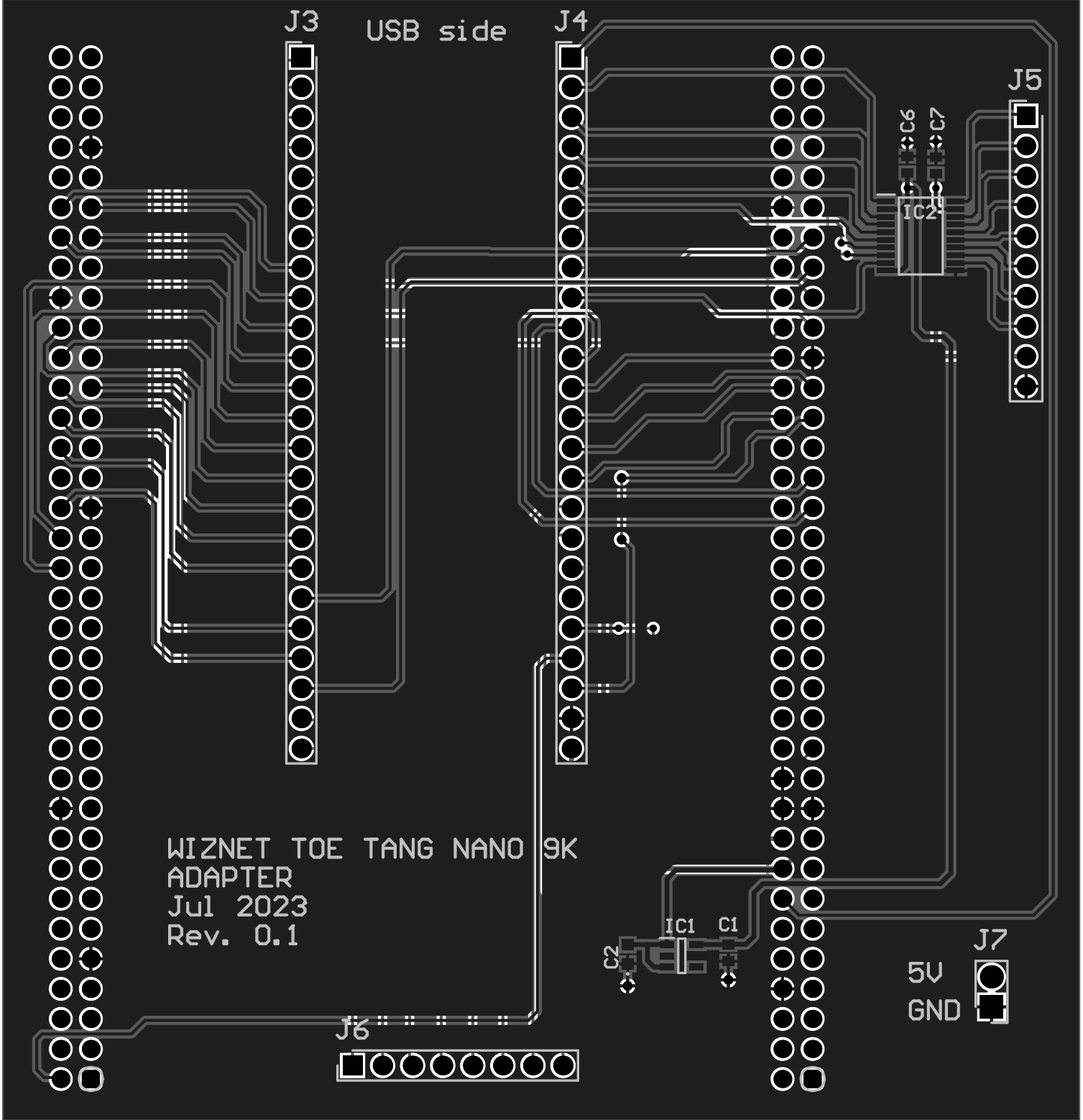

USB side

J3

J4

J5

WIZNET TOE TANG NANO 9K
ADAPTER
Jul 2023
Rev. 0.1

J6

C2

IC1

C1

5V

GND

J7

IC2

C6

IC1

C7

C5